

HIGH PERFORMANCE STRUCTURED CABLING PRODUCTS AND SOLUTIONS

Copper Workstation

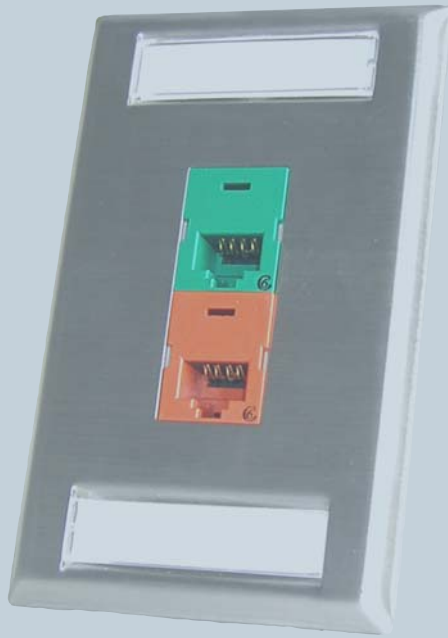

Evolving networks demand the technology to support elevated performance requirements. Reality necessitates this elevated performance be delivered via a design that will meet specific mechanical, environmental and aesthetic workstation requirements. Ortronics/Legrand provides industry leading performance in both the individual footprint of TracJack® and the rugged module footprint of Series II®—two premium workstation approaches with a common mission to provide the best quality, performance and value.

TracJack Modules



TracJack Faceplates



Series II Modules & Faceplates

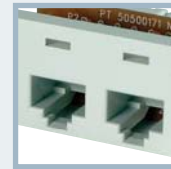

Multimedia Workstations



FEATURED PRODUCTS



Clarity^{10G} TracJack
pg. 20



P.20
Clarity^{10G}
TracJacks



P.20
Clarity⁶ and
Clarity^{5E} Center
Tuned, Enhanced
Category 6 and
5e TracJacks



P.21
Additional
TracJack
Modules for
Other Media



P.22
Single Gang and
Double Gang
Plastic TracJack
Faceplates



P.24
Surface
Housings
for TracJack

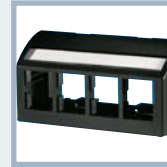

P.25
TracJack
Furniture Bezels



P.26
Clarity⁶ and
Clarity^{5E} Center
Tuned, Enhanced
Category 6 and 5e
Series II Modules



P.26
Series II
Connector
Modules



P.27
Additional Series
II Connector
Modules for
Other Media



P.27
Single Gang
Plastic, Double
Gang Plastic and
Angled
Series II
Faceplates



P.28
Surface Housings
for Series II



P.28
Furniture Plates
for Series II



P.29
Fib-or-Cop II



P.29
MUTOA Mac-Pak



P.30
Multimedia
Outlet (MMO)



**TracJack
Undercover
Wallplate
pg. 24**



**Fib-or-Cop II
pg. 29**



TracJack® Modules

NOTE: All Ortronics product dimensions are listed by width, height and depth unless specified otherwise.

TracJack® modules combine the ease and reliability of a front-loading individual jack with preferred 110 termination and offer universal T568A/B wiring.



Clarity^{10G} TracJacks

Clarity^{10G} TracJacks are the first connectors to utilize synchronized reactance to minimize internal crosstalk and reduce the injection of common mode noise, a significant source of alien crosstalk. These connectors work with Clarity^{10G} patch cords to provide a nearly transparent signal path for enhanced signal-to-noise (internal and alien) performance.

These front-loading jacks are icon-compatible and can be used in any TracJack workstation outlet or in the Clarity^{10G} individual jack panel. Meets TIA T568B.2-10 (draft 5 augmented Category 6) component specifications.

PART NO.	DESCRIPTION
OR-TJ610	TracJack, Clarity® 10 Gig, 180° exit, fog white

Clarity^{10G} jacks are available in these colors: -00=black, -36=blue, -42=red, -43=orange, -44=yellow, -45=green, -68=Wiremold® gray, -88=cloud white, -99=Wiremold ivory. Add tailcode to end of part number.



Clarity⁶ and Clarity^{5E} Center Tuned, Enhanced Category 6 and 5e TracJacks

Ortronics Clarity⁶ TracJacks feature the improved performance of center tuned Category 6 or 5e connector technology. Enhanced IDC designs make it easier to terminate while reducing the size of the jack.

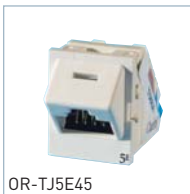
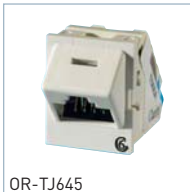

PART NO.	DESCRIPTION
OR-TJ600	Category 6 jack, 8-position, 180° exit, fog white
OR-TJ645	Category 6 jack, 8-position, 45° exit, fog white
OR-TJ5E00	Category 5e jack, 8-position, 180° exit, fog white
OR-TJ5E45	Category 5e jack, 8-position, 45° exit, fog white

NOTE: T568A/B wiring. Icon compatible. See color chart below for available colors.

fog white	-00	-13	-36	-42	-43	-44	-45	-68
-78	-88	-99	-22	-23	-24	-25	-26	-27

NOTE: Clarity TJ5E00 and TJ600 jacks are available in all colors listed above. The Clarity TJ5E45 and TJ645 are not available in colors 22-27. WM indicates Wiremold color match. These color samples correspond with the tail codes inserted at the end of Ortronics part numbers (ex: OR-TJ600-45). Fog white is standard, requiring no tail code. Consult sales for availability and other colors.

TracJack® Modules

See page 158 for Fiber TracJack modules

NOTE: All Ortronics product dimensions are listed by width, height and depth unless specified otherwise.

Additional TracJack® Modules



PART NO.	DESCRIPTION
OR-63730003	Category 3 jack, 8-position, 180° exit, T568A/B wiring, Icon compatible
OR-63700005*	RJ25 jack, 6-position, 180° exit, USOC wiring, Icon compatible
OR-63700006*	F-Connector F/F (75-ohm), 180° exit
OR-63700025*	S-Video (4-pin DIN) to 110, 180° exit
OR-63700046*	Pair of RCA to 110 (one red, one black), 180° exit
OR-63700047	RCA (yellow insulator) to 110, 180° exit
OR-63700070	RCA (white insulator) to 110, 180° exit
OR-63700071	RCA (red insulator) to 110, 180° exit
OR-63700058	RCA F/F (red insulator), 180° exit
OR-63700059	RCA F/F (white insulator), 180° exit
OR-63700023	BNC connector (50 ohm) F/F, 180° exit
OR-42100002*	Package of ten blanks
OR-63700069	3.5 mm stereo jack, F/F, 180° exit, fog white

NOTE: Standard color for TracJack modules is fog white.
 *Indicates also available in -99 Wiremold ivory and -88 cloud white. Contact Ortronics sales department for other colors.

Clarity® Shielded TracJack Modules

Clarity Shielded TracJacks meet TIA Category 6 and Category 5e component specifications and are precisely tuned to the terminated plug values of Clarity patch cords for optimum performance that is field measurable in the channel. Clarity uses dual reactance technology to enhance signal-to-noise ratio, providing a nearly transparent signal path.

- Exceeds ISO 11801 2nd edition including EN50173 2nd edition
- Meets IEC 60603-7-5 2nd edition (draft) specifications
- ETL 3rd party component tested and verified
- Easy lace IDC housing designed to accept larger Category 6 conductors
- Easy to follow universal wiring label—quick and user-friendly, eliminates confusion
- Fits in all TracJack plates and housings
- Icon compatible, C6 and 5E marking on jack face
- Backward compatible to shielded Category 3, 5 and 5e
- Center tuned connectivity design
- Compatible with 110 impact tool

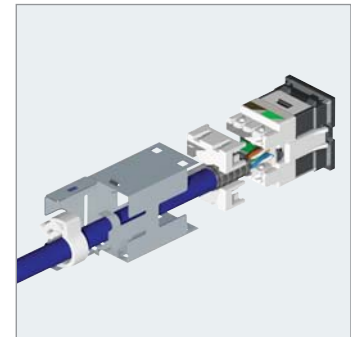

Clarity⁶ and Clarity^{5E} Shielded Category 6 and 5e TracJacks

PART NO.	DESCRIPTION
OR-TJS600	Clarity ⁶ , Category 6 jack, 8-position, 180° exit
OR-TJS5E00	Clarity ^{5E} , Category 5e jack, 8-position, 180° exit

NOTE: T568A/B wiring.

TracJack® Faceplates

NOTE: All Ortronics product dimensions are listed by width, height and depth unless specified otherwise.

Ortronics offers a full range of TracJack® faceplates in plastic or stainless steel, with a variety of port capacities to match your workstation applications. All TracJack plates offer recessed label fields and slotted screw holes to adjust alignment. They are ruggedly constructed from high impact thermo-plastic 94V-0 rated to ensure long life. Two to 12-port plastic wall plates now include the ability to rear-load TracJack modules.

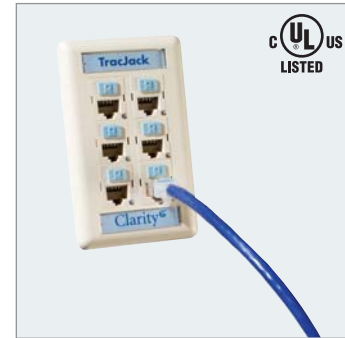

Single Gang Plastic TracJack Faceplates



PART NO.	DESCRIPTION
OR-40300549	Holds one TracJack, 2.75" x 4.5"
OR-40300548	Holds two TracJacks, 2.75" x 4.5"
OR-40300547	Holds three TracJacks, 2.75" x 4.5"
OR-40300546	Holds four TracJacks, 2.75" x 4.5"
OR-40300545	Holds six TracJacks, 2.75" x 4.5"

NOTE: Standard color for plastic TracJack faceplates is fog white. For electrical ivory add -13, for cloud white add -88 and for Wiremold® ivory add -99 to end of part number. For other colors, contact sales.

Single Gang Stainless Steel TracJack Faceplates



PART NO.	DESCRIPTION
OR-403STJ11	Holds one TracJack, 2.75" x 4.5"
OR-403STJ12	Holds two TracJacks, 2.75" x 4.5"
OR-403STJ13	Holds three TracJacks, 2.75" x 4.5"
OR-403STJ14	Holds four TracJacks, 2.75" x 4.5"
OR-403STJ16	Holds six TracJacks, 2.75" x 4.5"

Double Gang Plastic TracJack Faceplates



PART NO.	DESCRIPTION
OR-40300555	Holds six TracJacks, 4.5" x 4.5"
OR-40300554	Holds eight TracJacks, 4.5" x 4.5"
OR-40300620	Holds twelve TracJacks, 4.5" x 4.5"

NOTE: Standard color for TracJack plastic faceplates is fog white. For other available colors, contact sales.

Double Gang Stainless Steel TracJack Faceplates



PART NO.	DESCRIPTION
OR-403STJ28	Holds eight TracJacks, 4.5" x 4.5"
OR-403STJ212	Holds twelve TracJacks, 4.5" x 4.5"

TracJack® Plate Mountings

NOTE: All Ortronics product dimensions are listed by width, height and depth unless specified otherwise.

Ortronics/Legrand offers TracJack® mountings in both the 106-Type duplex footprint or the Stylistics® rectangular (GFCI) footprint, with a variety of port capacities to match your workstation applications. These two footprints are common to Wiremold® and many other industry standard raceway, furniture, pedestals and floor boxes. Ortronics also offers plastic cover plates with recessed label fields and slotted screw holes to adjust alignment. All parts are ruggedly constructed from high impact thermo-plastic 94V-0 rated to ensure long life.



106-Type TracJack Frames



PART NO.	DESCRIPTION
OR-40800017*	Holds two TracJacks
OR-40800018*	Holds three TracJacks
OR-40800019*	Holds four TracJacks

NOTE: Standard color is fog white.

* Indicates also available in -99 Wiremold ivory and -88 cloud white.

Stylistics TracJack Frames



PART NO.	DESCRIPTION
OR-41900017*	Holds three TracJacks
OR-41900018*	Holds four TracJacks

NOTE: Standard color is fog white.

* Indicates also available in -99 Wiremold ivory and -88 cloud white.

Stylistics Plastic Cover Plates



PART NO.	DESCRIPTION
OR-40300270	Single gang cover, 2.75" x 4.5"
OR-40300271	Double gang cover, 4.5" x 4.5"

NOTE: Standard color for 106-Type and Stylistics Cover Plates is fog white. For cloud white add -88, for Wiremold ivory add -99 to end of part number. For other colors, contact sales.

106-Type Plastic Cover Plates



PART NO.	DESCRIPTION
OR-40300255	Single gang cover, 2.75" x 4.5"
OR-40300256	Double gang cover, 4.5" x 4.5"

Single Gang Stainless Steel TracJack Faceplates with Phone Studs



PART NO.	DESCRIPTION
OR-403STJ1WP	Holds one TracJack, 2.75" x 4.5"

NOTE : Not compatible with 2554 series wall phones.

TracJack® Undercover Wall Plate

NOTE: All Ortronics product dimensions are listed by width, height and depth unless specified otherwise.



OR-403TJUSG

TracJack Undercover Wall Plate

The TracJack® Undercover provides a protective housing for four center mount TracJacks with the ability to add an additional copper or fiber TracJack out the bottom. This single gang housing offers increased protection for connections in tamper sensitive environments.

PART NO.	DESCRIPTION
OR-403TJUSG	Single gang protective housing holds up to five TracJack modules, 5.58"H x 2.25"D x 2.74"W

TracJack Surface Mount Boxes

NOTE: All Ortronics product dimensions are listed by width, height and depth unless specified otherwise.

Ortronics TracJack surface mount boxes are available to house from two to six TracJacks. Bases are easily installed with supplied screws or double-sided adhesive. Snap-on covers have recessed label fields. Boxes are ruggedly constructed from high impact thermo-plastic 94V-0 rated. Standard color is fog white.



Surface Housings for TracJack



OR-404TJ2



OR-404TJ4



OR-404TJ2X2



OR-404TJ6

PART NO.	DESCRIPTION
OR-404TJ2	Holds two TracJacks, 2.59" x 2.27" x 1.20"
OR-404TJ4	Holds four TracJacks, 4.80" x 3.6" x 1.16" NOTE: Can mount directly to single gang recessed wall boxes. Includes one TracJack blank.
OR-404TJ2X2	Holds four TracJacks, jacks exit from both sides, 4.0" x 2.42" x 1.16"
OR-404TJ6	Holds six TracJacks, 6.98" x 4.33" x 1.16" NOTE: Includes internal storage ring for fiber and two TracJack blanks. Can mount directly to single or double gang recessed wall boxes.

TracJack® Furniture Bezels

NOTE: All Ortronics product dimensions are listed by width, height and depth unless specified otherwise.

Ortronics/Legrand offers TracJack® plates for most furniture systems. Plates easily snap mount, requiring no special tools. Plates are ruggedly constructed from high impact thermo-plastic 94V-0 rated.

IMPORTANT: Measure furniture openings to determine the correct plate.



Furniture Plates for TracJack



PART NO.	DESCRIPTION
OR-40300577	Holds four TracJacks, fits Herman Miller Beltline furniture openings 2.35" x 3.41" (+.015) for .125" thick material
OR-40300577-00	Black
OR-40300576	Holds six TracJacks, fits Herman Miller Beltline furniture openings 2.35" x 3.41" (+.015) for .125" thick material
OR-40300576-00	Black
OR-40300575	Holds six TracJacks, fits Herman Miller Baseline furniture openings 1.89" x 2.99" (+.015) for .063" thick material
OR-40300575-00	Black
OR-40300633	Holds four TracJacks, two-piece base and cover, adjustable to fit a range of common furniture openings (2.67"-2.75" x 1.34"-1.41") for .065" thick material, fog white
OR-40300633-00*	Black
OR-42100009	Adapter plate, front-loads three TracJacks, fog white
OR-42100009-00	Black
OR-42100054	Adapter plate, rear-loads three TracJacks, fog white, five pack
OR-42100054-00	Black, five pack
OR-40700071	.125" deep bezel mounts adapter plate to 2.71" x 1.38" (+.035) opening, fog white
OR-40700071-00	Black
OR-40700072*	.625" deep bezel mounts adapter plate to 2.71" x 1.38" (+.035) opening, fog white
OR-40700072-00*	Black
OR-40700073*	1.0" deep bezel mounts adapter plate to 2.71" x 1.38" (+.035) opening, fog white
OR-40700073-00*	Black

* Have recessed label fields



Clarity® Series II® Modules

NOTE: All Ortronics product dimensions are listed by width, height and depth unless specified otherwise.

Ortronics Clarity® Series II® modules combine the improved performance of center tuned Category 6 or 5e connector technology with the ease and reliability of rugged, front-loading Series II modules with linear 110 termination.



Clarity⁶ and Clarity^{5E} Enhanced Category 6 and 5e Series II Modules



PART NO.	DESCRIPTION
OR-S21600	Single enhanced Category 6 jack, 8-position, 180° exit, universal T568A/B wiring
OR-S22600	Dual enhanced Category 6 jack, 8-position, 180° exit, universal T568A/B wiring
OR-S215E00	Single enhanced Category 5e jack, 8-position, 180° exit, universal T568A/B wiring
OR-S225E00	Dual enhanced Category 5e jack, 8-position, 180° exit, universal T568A/B wiring

NOTE: Clarity Series II modules are available in -99 Wiremold® ivory, -88 cloud white and -00 black. Icon compatible.

Additional Series II Jack Modules



PART NO.	DESCRIPTION
OR-S21RJ61	Single USOC RJ61 jack, 8-position, 180° exit
OR-S22RJ61	Dual USOC RJ61X jack, 8-position, 180° exit
OR-S22RJ25-5E	Single RJ25 USOC 6-position jack, single T568A/B Category 5e, 8-position jack, 180° exit
OR-S21RJ25	Single USOC RJ25 jack, 6-position, 180° exit
OR-S22RJ25	Dual USOC RJ25 jack, 6-position, 180° exit

NOTE: See page 159 for Fiber Series II modules

Series II Connector Modules



PART NO.	DESCRIPTION
OR-60900017	One F-connector, F/F (2 GHz), 180° exit, 1 unit
OR-60900018	One BNC, F/F (50 ohm), 180° exit, 1 unit
OR-60900019	Two BNCs, F/F (50 ohm), 180° exit, 1 unit
OR-60900020	Two F-connectors, F/F (2 GHz), 180° exit, 1 unit
OR-60900073	One F-connector, F/F (2 GHz), 45° exit, 2 units
OR-60900315	Two RCA/Phono jacks (white/red), solder termination, 180° exit, 1 unit

Series II® Modules

See page 159 for Series II Fiber modules

NOTE: All Ortronics product dimensions are listed by width, height and depth unless specified otherwise.

Additional Series II Connector Modules



PART NO.	DESCRIPTION
OR-60900235	Three RCA/phono jacks (white/red/yellow), 110 IDC termination, 180° exit, 1 unit
OR-60900314	Two RCA/phono jacks (white/red), 110 IDC termination, 180° exit, 1 unit
OR-60900316	Three RCA/phono jacks (white/red/yellow), F/F, 180° exit, fog white, 1 unit
OR-60900212	Two RCA/phono jacks (white/red), F/F, 180° exit, fog white, 1 unit
OR-60900074	S-Video (4-pin DIN), F/F, 180° exit, 1 unit
OR-60900225	S-Video (4-pin DIN), F to 110 IDC termination, 180° exit, 1 unit
OR-40300144	Blank module, .5 unit
OR-40300164	Blank module, 1 unit
OR-40300191	Blank modules, 1 unit, package of ten
OR-40300023	Blank module, 1.5 units
OR-60900270	DB15-HD F/F VGA, 1 unit
OR-60900273	3.5 mm stereo jack, F/F, 180° exit, fog white
OR-60900313	DB15-HD F, VGA with crimp pins, 1 unit
OR-40300656	Series II angled bezel, accepts two TracJack modules, ten pack, 1.5 units
OR-40300749	Series II flush bezel, accepts two TracJack modules, 180° exit, 1 unit, package of ten

Series II Module Combinations

3 Unit Series II Outlet Opening

1 UNIT	1.5 UNIT	1 UNIT	3 UNIT
1 UNIT		2 UNIT	
1 UNIT	1.5 UNIT		

2 Unit Series II Outlet Opening

1 UNIT	1.5 UNIT	2 UNIT
1 UNIT	.5 UNIT (Blank)	

Series II Faceplates

NOTE: All Ortronics product dimensions are listed by width, height and depth unless specified otherwise.

Ortronics/Legrand offers single and double gang Series II plastic faceplates with a variety of port capacities to match your workstation applications. Series II plates offer recessed label fields, slotted screw holes to adjust alignment, and are ruggedly constructed from high impact thermo-plastic 94V-0 rated to ensure long life.



Single Gang Plastic, Double Gang Plastic and Angled Series II Faceplates



Single Gang Plastic Series II Faceplates

PART NO.	DESCRIPTION
OR-40300158	Low profile, .5" deep, fog white, 2.75" x 4.5"
OR-40300011	Standard profile, .75" deep, fog white, 2.75" x 4.5"

Double Gang Plastic Series II Faceplates

PART NO.	DESCRIPTION
OR-40300159	Standard profile, .75" deep, fog white, 4.5" x 4.5"
OR-40300175	High profile, 1.65" deep, fog white, 4.5" x 4.5"

Angled Series II Faceplates

PART NO.	DESCRIPTION
OR-40300664	Single gang angled Series II faceplate holds two 1 unit modules, 4.5" x 4.5"



Series II® Surface Mount Interface Boxes

NOTE: All Ortronics product dimensions are listed by width, height and depth unless specified otherwise.

Ortronics Series II surface mount boxes are available to house one to four 1-unit modules. Bases are easily installed with supplied screws or double-sided adhesive. Snap-on covers have recessed label fields. Series II surface mount boxes are ruggedly constructed from high impact thermo-plastic 94V-0 rated. These surface mount boxes work with 180° modules only.



Surface Housings for Series II



PART NO.	DESCRIPTION
OR-404S21U	Holds one 1-unit Series II module, fog white, 2.27" x 2.59" x 1.20"
OR-404S22U	Holds two 1-unit Series II modules, fog white, includes one Series II blank, 3.60" x 4.80" x 1.16"
OR-404S21X1U	Holds two 1-unit Series II modules, fog white, includes one Series II blank, 4.00" x 2.42" x 1.16"
OR-404S23U	Holds three 1-unit Series II modules, internal fiber storage ring, fog white, 4.33" x 6.98" x 1.16"
OR-404S22X2U	Holds four 1-unit Series II modules, fog white, includes two Series II blanks, 4.00" x 4.71" x 1.16"

NOTE: Does not accept 45° modules.

Furniture Plates for Series II

Ortronics/Legrand offers a wide selection of Series II plates for the many furniture systems available today. Plates easily snap mount, requiring no special tools. Plates are ruggedly constructed from high impact thermo-plastic 94V-0 rated.

IMPORTANT: Measure furniture openings to determine the correct plate.

NOTE: All Ortronics product dimensions are listed by width, height and depth unless specified otherwise.



Furniture Plates



PART NO.	DESCRIPTION
OR-40300196	Holds three 1-unit Series II modules, fog white, fits Herman Miller Baseline furniture openings 1.89" x 2.99" (+.015) for .0625" thick material
OR-40300196-00	Black
OR-40300213	Holds three 1-unit Series II modules, fog white, fits Herman Miller Beltline furniture openings 2.35" x 3.41" (+.015) for .125" thick material
OR-40300167	Holds one 1-unit Series II modules, black, 2.7" x 1.375" (+.03) for .090" thick material
OR-40300167-09	Fog white

Multimedia Workstations

NOTE: All Ortronics product dimensions are listed by width, height and depth unless specified otherwise.

Ortronics Fib-or-Cop workstation solutions service a broad scope of multimedia applications, supporting sound cabling practices in an attractive and user-friendly design.

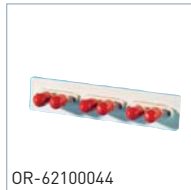

Fib-or-Cop II

Fib-or-Cop II offers greater capacity, accommodating up to 12 fiber connections with protected exit from the bottom, and six copper connections, either TracJack® or Series II®. This is a truly segregated design, which allows access to one media without impacting the other. Bottom-exiting connections can be further protected with an optional snap-on shroud.

PART NO.	DESCRIPTION
OR-62100041	Base and cover for six TracJacks, 5" x 8" x 1.19"
OR-62100040	Base and cover for three Series II modules, 5" x 8" x 1.19"
OR-62100037	Package of five bottom adapter plates for four TracJack modules
OR-62100038	Package of five protective bottom shrouds
OR-62100044	3-ST duplex (6 fibers) multimode, beige adapters, phosphor-bronze alignment sleeves
OR-62100045	3-ST duplex (6 fibers) single-mode, blue adapters, ceramic alignment sleeves
OR-62100046	6-SC simplex (6 fibers) multimode, beige adapters, phosphor-bronze alignment sleeves
OR-62100047	6-SC simplex (6 fibers) single-mode, blue adapters, ceramic alignment sleeves
OR-62100048	3-SC duplex (6 fibers) multimode, beige adapters, phosphor-bronze alignment sleeves
OR-62100049	3-SC duplex (6 fibers) single-mode, blue adapters, ceramic alignment sleeves
OR-62100050	6-LC duplex (12 fibers) multimode, beige adapters, phosphor-bronze alignment sleeves
OR-62100051	6-LC duplex (12 fibers) single-mode, blue adapters, ceramic alignment sleeves
OR-62100052	6-MT-RJ (12 fibers) feed-through multimode, beige adapters
OR-62100053	6-MT-RJ (12 fibers) single-mode, blue adapters



Clarity® and Clarity^{SE} Jak-Paks

The Jak-Pak is a compact, flexible, multi-user solution that can be structurally mounted or used in more temporary environments. Kits come supplied with Clarity® or Clarity^{SE} six-port/110 modules.

PART NO.	DESCRIPTION
OR-JP66U	Clarity® Jak-Pak, six-port multi-access outlet field termination kit, T568A/B
OR-JP5E6U	Clarity ^{SE} Jak-Pak, six-port multi-access outlet field termination kit, T568A/B



MUTOA Mac-Pak

The MUTOA Mac-Pak is a compact, flexible, multi-user solution that can be structurally mounted or used in more temporary environments. Kits come ready to accept flat TracJack® modules.

PART NO.	DESCRIPTION
OR-60950301	Accepts eight TracJacks, black housing

Multimedia Workstations

NOTE: All Ortronics product dimensions are listed by width, height and depth unless specified otherwise.

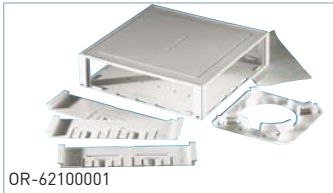

OR-6210001

Multimedia Outlet (MMO)

Ortronics Multimedia Outlet (MMO) is a high capacity, field configurable workstation housing. The MMO comes with three blank panels with cable access knockouts. A wide range of MMO panels are available to support your specific applications. MMO mounts directly to any single or double gang recessed wall box or to any surface. Labeling is supplied.

PART NO.	DESCRIPTION
OR-6210001	Cover base and three blank panels, 6.75" x 6.75 x 1.68", fog white



OR-41200004



OR-41200010

MMO Panels

PART NO.	DESCRIPTION
OR-41200004	Accepts two 1-unit Series II® modules
OR-41200010	Accepts one fiber adapter panel, see page 125
OR-41200012	Accepts two OR-42100009 TracJack® adapters
OR-42100009	Accepts three TracJacks



OR-41200012



OR-42100009

Accessories



NOTE: All Ortronics product dimensions are listed by width, height and depth unless specified otherwise.



OR-40300061



OR-40300185-13

Surface Mount Outlet Boxes

Ortronics surface mount outlet boxes are compatible with all Ortronics single and double gang faceplates. These boxes provide a mounting surface for faceplates or can be attached to recessed boxes to provide greater cable storage capacity.

PART NO.	DESCRIPTION
OR-40300061	Single gang, low profile, fog white, 3" x 4.7" x 1.5"
OR-40300185	Single gang, fog white, 3" x 4.7" x 2"
OR-40300185-13	Electrical ivory
OR-70900020	Adhesive-back single gang magnet
OR-40300186	Double gang, fog white, 4.9" x 4.7" x 2"
OR-70900022	Adhesive-back double gang magnet
OR-70700070	Double-sided adhesive kit (use two for double gang)



OR-70900020



OR-40300186

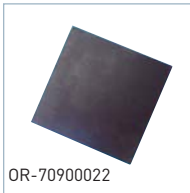

OR-70900022



OR-70700070

Accessories

NOTE: All Ortronics product dimensions are listed by width, height and depth unless specified otherwise.



Extension Plate

Ortronics extension plate provides an additional .9" of depth behind single gang faceplates for bend radius requirements or cable storage.

PART NO.	DESCRIPTION
OR-40300010	Single gang extension plate, fog white, 2.75" x 4.5" x .9"

Labeling and Designation Solutions



Work Outlet Station Designation

Color-coded designation strips provide easy identification for workstations. Designation strips are supplied in 8.5" x 11" sheets of laser feed paper.

Supported by the LabelMo XL templates.

NEW

LabelMo XL Labeling Templates

The LabelMo XL templates provide a new format for your labeling needs that increases flexibility and ease of use.

- Provided in an easy-to-use Excel format
- Uses our standard 8.5" x 11" label stock
- Access online 24/7 via www.ortronics.com/us/products at no charge

PART NO.	DESCRIPTION
OR-70400411	White
OR-70400411-22	Red
OR-70400411-23	Orange
OR-70400411-24	Yellow
OR-70400411-25	Green
OR-70400411-26	Blue

NOTE: Ten sheets per package, 96 labels per sheet.

Replacement Designation Strip Covers

PART NO.	DESCRIPTION
OR-70400202	Workstation, package of ten



Series II® Designation Tabs

Ortronics Series II designation tabs snap into flush and innie Series II modules to identify each port. Accommodates two one-port modules. Standard color is fog white. Package of 12.

PART NO.	DESCRIPTION
OR-70400219	Series II designation tabs



Color-Coded Icons

Ortronics color-coded designation tabs are for port identification on patch panels and most workstation products. The tabs are available in 606 standard colors with a voice or data icon or blank. Package of 100.

OR-403	XX	X	00	Ordering example: To order a red voice tab, use the following part number OR-40322100
Manufacturer Number	Coloring	Marking		
	00=Black	23=Orange,	1=Voice	
	22=Red	25=Green,	2=Data	
	24=Yellow	27=Purple,	5=Blank	
	26=Blue	09=Fog White,		
	13=Electrical Ivory			

NOTE: For a complete set of voice and data tabs in all colors, use order number OR-40300174.